

**NKI25/30-XL**

Needle roller bearing

Schaeffler ID:
0507621500000

Needle roller bearings NKI, light series

X-life

Technical information

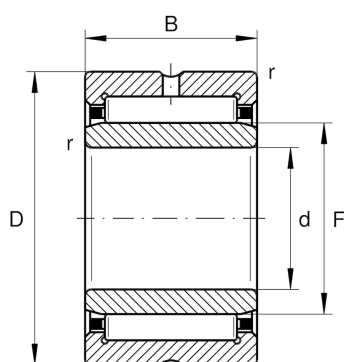
**Main Dimensions & Performance Data**

d	25 mm	Bore diameter
D	38 mm	Outside diameter
B	30 mm	Width
C_r	37,000 N	Basic dynamic load rating, radial
C_{0r}	57,000 N	Basic static load rating, radial
C_{ur}	10,700 N	Fatigue load limit, radial
n_G	15,300 1/min	Limiting speed
n_{gr}	8,200 1/min	Reference speed
	119.69 g	Weight

Dimensions

F	29 mm	Raceway diameter inner ring
r_{min}	0.3 mm	Minimum chamfer dimension
s	1.5 mm	Axial displacement

Temperature range

T_{min}	-30 °C	Operating temperature min.
T_{max}	120 °C	Operating temperature max.